

BROOKE-G2-S

~20° spot beam compatible with LEDiL HEKLA.

TECHNICAL SPECIFICATIONS:

Dimensions	Ø 45.0 mm
Height	18.9 mm
Fastening	socket
Colour	metal
Box size	480 x 280 x 300 mm
Box weight	4.8 kg
Quantity in Box	720 pcs
ROHS compliant	yes ⓘ





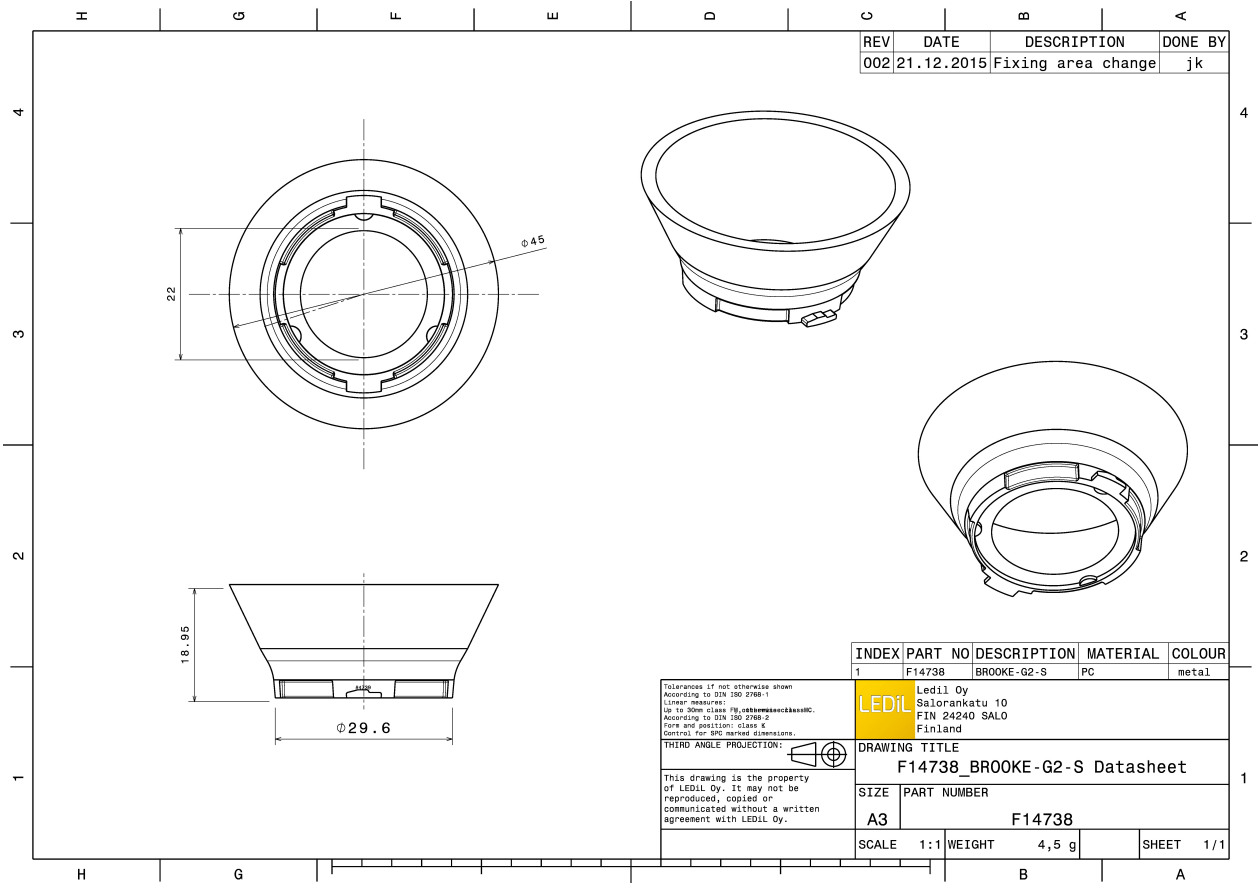

MATERIAL SPECIFICATIONS:

Component	Type	Material	Colour	Coating
BROOKE-G2-S	Reflector	PC	metal	HMDS

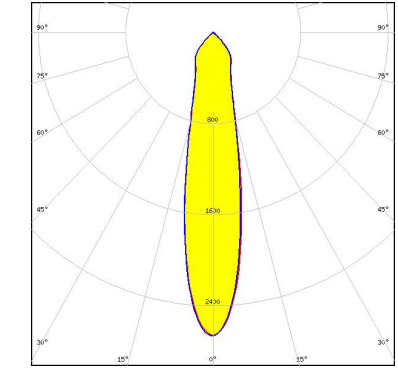

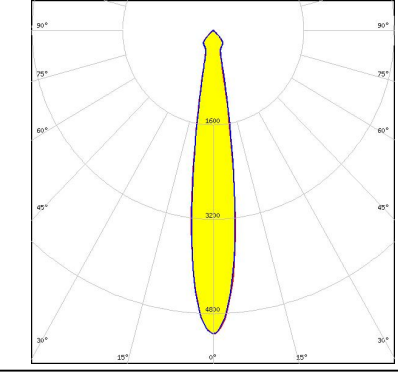
PHOTOMETRIC DATA (MEASURED):

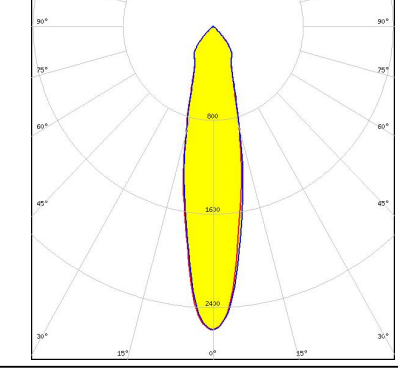
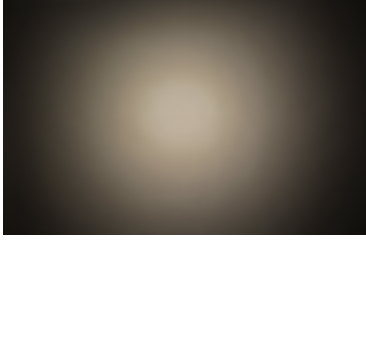
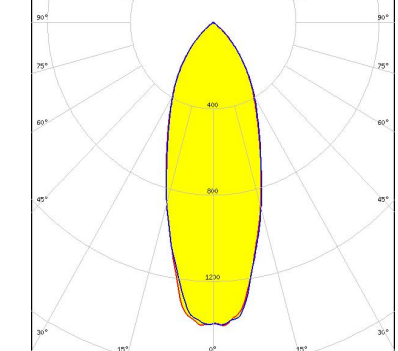
<p>bridgelux.</p> <p>LED V10 Gen7</p> <p>FWHM 22.0°</p> <p>Efficiency 88 %</p> <p>Peak intensity 2.700 cd/lm</p> <p>Required components: F15255_HEKLA-SOCKET-C C14658_BARBARA-RZ-LENS</p>		
<p>bridgelux.</p> <p>LED VERO10</p> <p>FWHM 16.0°</p> <p>Efficiency 94 %</p> <p>Peak intensity 5.100 cd/lm</p> <p>Required components: F15616_HEKLA-SOCKET-F</p>		
<p>bridgelux.</p> <p>LED VERO13</p> <p>FWHM 23.0°</p> <p>Efficiency 90 %</p> <p>Peak intensity 2.600 cd/lm</p> <p>Required components: C16142_HEKLA-SOCKET-K</p>		
<p>bridgelux.</p> <p>LED VERO18</p> <p>FWHM 38.0°</p> <p>Efficiency 89 %</p> <p>Peak intensity 1.400 cd/lm</p> <p>Required components: LEDiL: C16142_HEKLA-SOCKET-K</p>		

PHOTOMETRIC DATA (MEASURED):

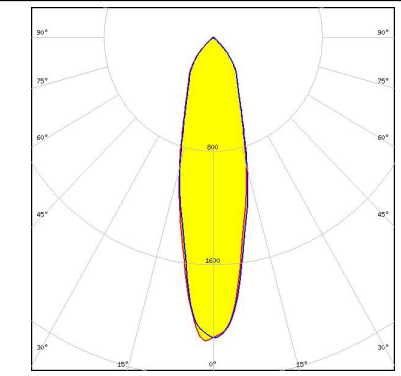
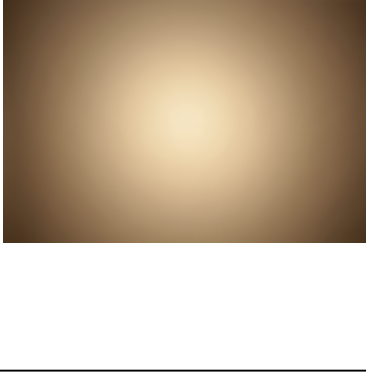
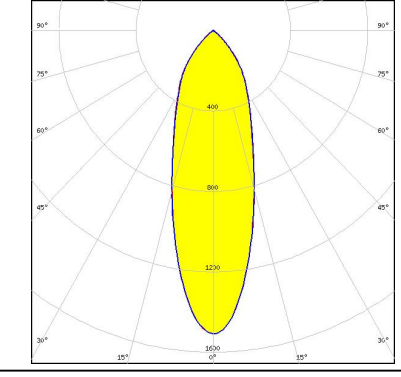
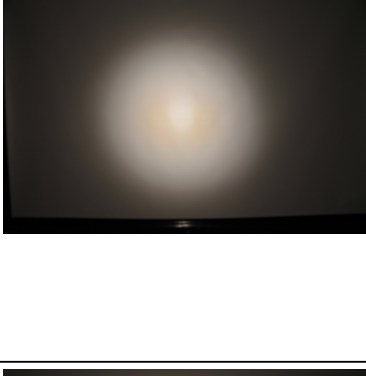
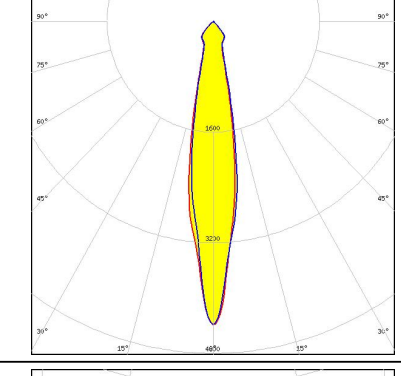
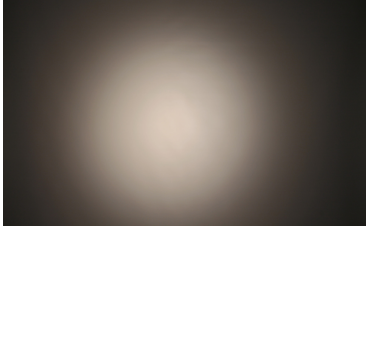
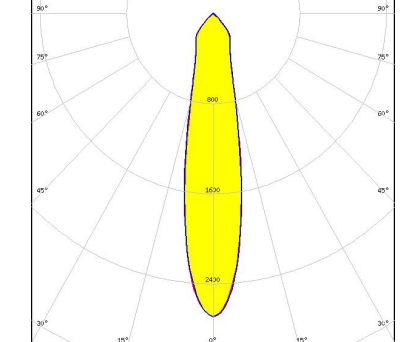
<p>bridgelux.</p> <p>LED Vesta DTW 15mm (33W)</p> <p>FWHM 27.0°</p> <p>Efficiency 91 %</p> <p>Peak intensity 2.100 cd/lm</p> <p>Required components: C16142_HEKLA-SOCKET-K Bender Wirth: 491 Typ L8</p>		
<p>bridgelux.</p> <p>LED Vesta DTW 15mm (33W)</p> <p>FWHM 33.0°</p> <p>Efficiency 84 %</p> <p>Peak intensity 1.500 cd/lm</p> <p>Required components: C16142_HEKLA-SOCKET-K C14658_BARBARA-RZ-LENS Bender Wirth: 491 Typ L8</p>		
<p>bridgelux.</p> <p>LED Vesta DTW 9mm (6W/12W)</p> <p>FWHM 18.0°</p> <p>Efficiency 92 %</p> <p>Peak intensity 4.400 cd/lm</p> <p>Required components: C16142_HEKLA-SOCKET-K Bender Wirth: 490 Typ L8</p>		
<p>bridgelux.</p> <p>LED Vesta DTW 9mm (6W/12W)</p> <p>FWHM 22.0°</p> <p>Efficiency 87 %</p> <p>Peak intensity 2.700 cd/lm</p> <p>Required components: C16142_HEKLA-SOCKET-K C14658_BARBARA-RZ-LENS Bender Wirth: 490 Typ L8</p>		

PHOTOMETRIC DATA (MEASURED):

CITIZEN

LED CLC020 Series (Dim-To-Warm)
FWHM 26.0°
Efficiency 84 %
Peak intensity 2.000 cd/lm
Required components:
C16142_HEKLA-SOCKET-K
C14658_BARBARA-RZ-LENS
Bender Wirth: 487 Typ L8

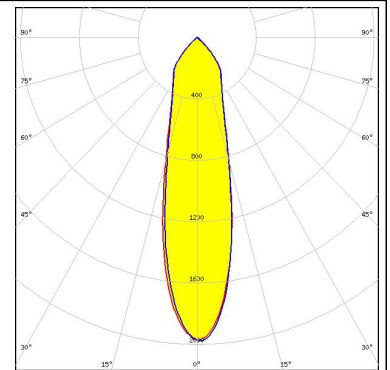
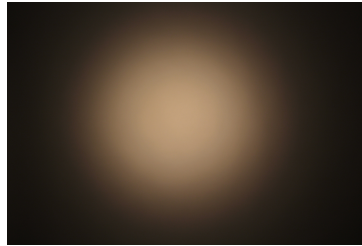

CITIZEN

LED CLC030 Series (Dim-To-Warm)
FWHM 30.0°
Efficiency %
Peak intensity 1.600 cd/lm
Required components:
C16142_HEKLA-SOCKET-K
C14658_BARBARA-RZ-LENS
Bender Wirth: 436 Typ L8

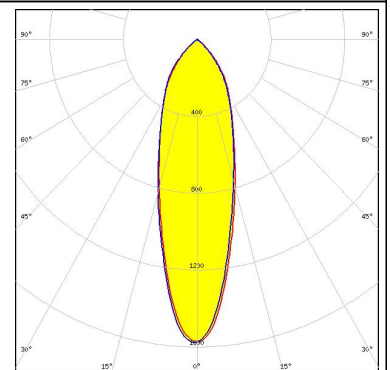
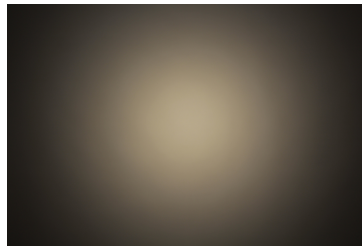

CITIZEN

LED CLC030 Series (Dim-To-Warm)
FWHM 23.0°
Efficiency 89 %
Peak intensity 2.200 cd/lm
Required components:
C16142_HEKLA-SOCKET-K

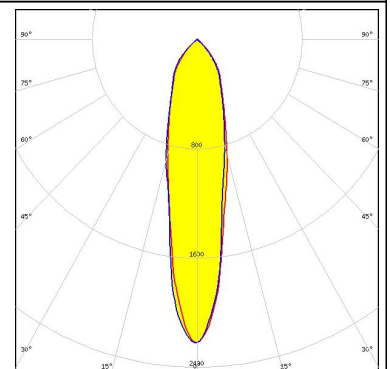
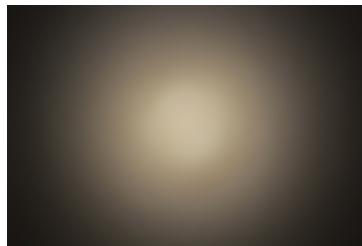

CITIZEN

LED CLL02x/CLU02x (LES10)
FWHM 16.0°
Efficiency 94 %
Peak intensity 4.800 cd/lm
Required components:
F15255_HEKLA-SOCKET-C

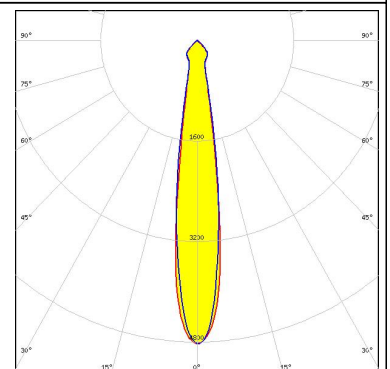
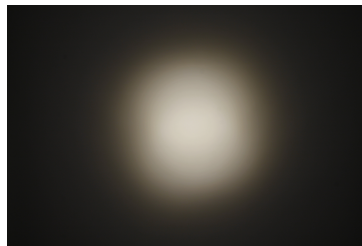

PHOTOMETRIC DATA (MEASURED):

CITIZEN

LED CLL02x/CLU02x (LES10)
 FWHM 16.0°
 Efficiency 94 %
 Peak intensity 4.800 cd/lm
 Required components:
 F15255_HEKLA-SOCKET-C

CITIZEN

LED CLU LES 4.2mm (HI-Ver.3)
 FWHM 8.0°
 Efficiency 94 %
 Peak intensity 15.900 cd/lm
 Required components:
 F15255_HEKLA-SOCKET-C

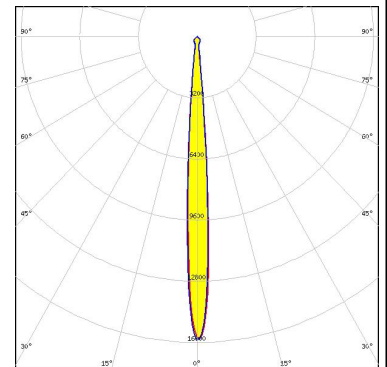

CITIZEN

LED CLU700/701
 FWHM 12.0°
 Efficiency 94 %
 Peak intensity 7.750 cd/lm
 Required components:
 F15255_HEKLA-SOCKET-C

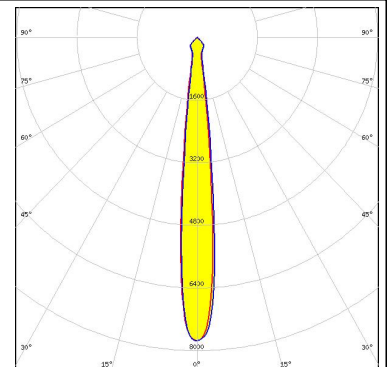
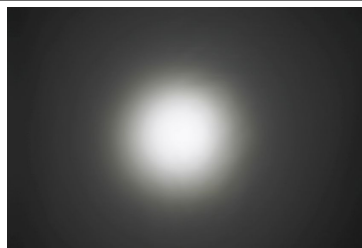

CITIZEN

LED LCN-C01B (Tunable White)
 FWHM 25.0°
 Efficiency 86 %
 Peak intensity 2.200 cd/lm
 Required components:
 C16142_HEKLA-SOCKET-K
 C14658_BARBARA-RZ-LENS
 Bender Wirth: 481 Typ L8

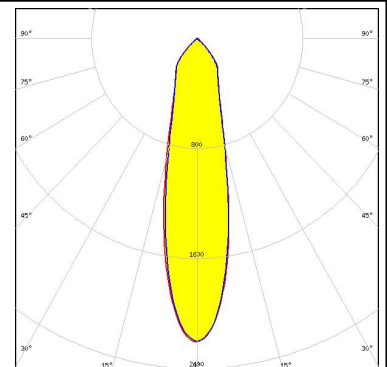
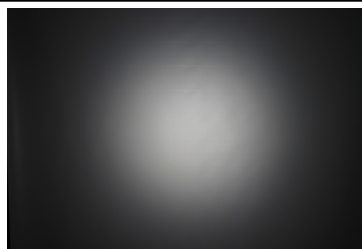

PHOTOMETRIC DATA (MEASURED):

CITIZEN

LED LCN-C02B (Tunable White)
 FWHM 27.0°
 Efficiency 89 %
 Peak intensity 2.300 cd/lm
 Required components:
 C16142_HEKLA-SOCKET-K

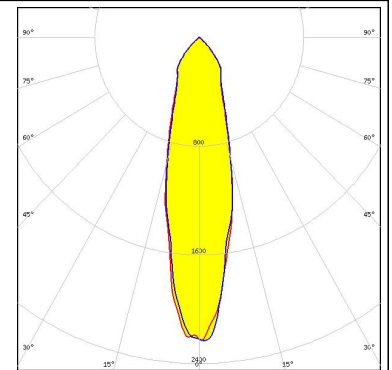

CITIZEN

LED LCN-C02B (Tunable White)
 FWHM 32.0°
 Efficiency 84 %
 Peak intensity 1.600 cd/lm
 Required components:
 C16142_HEKLA-SOCKET-K
 C14658_BARBARA-RZ-LENS
 Bender Wirth: 481 Typ L8

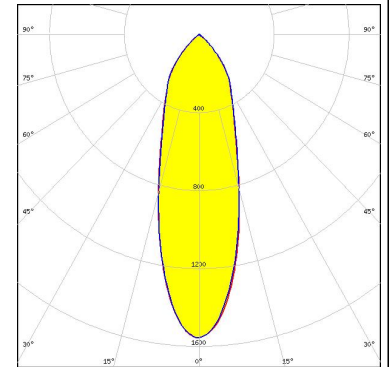
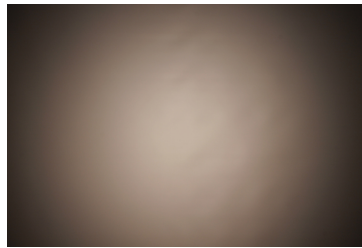

CREE

LED CMA1516
 FWHM 18.0°
 Efficiency 94 %
 Peak intensity 4.200 cd/lm
 Required components:
 F15256_HEKLA-SOCKET-D

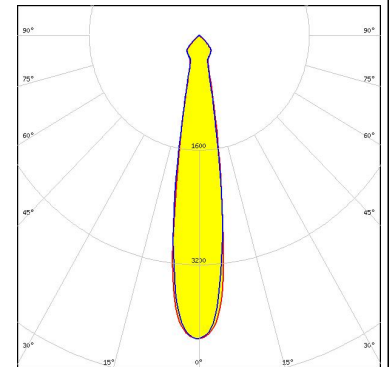

CREE

LED CMA1825
 FWHM 24.0°
 Efficiency 94 %
 Peak intensity 2.700 cd/lm
 Required components:
 F15254_HEKLA-SOCKET-B

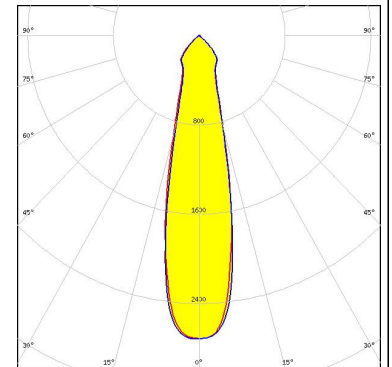
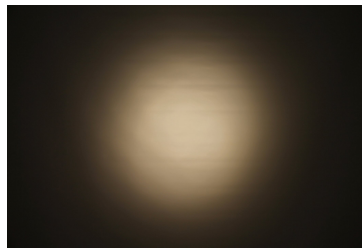

PHOTOMETRIC DATA (MEASURED):



LED CXA/B 13xx
 FWHM 11.0°
 Efficiency 94 %
 Peak intensity 8.200 cd/lm
 Required components:
 F15956_HEKLA-SOCKET-J

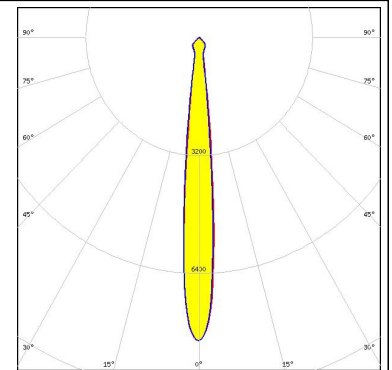

LED CXA/B 15xx
 FWHM 16.0°
 Efficiency 94 %
 Peak intensity 4.400 cd/lm
 Required components:
 F15256_HEKLA-SOCKET-D

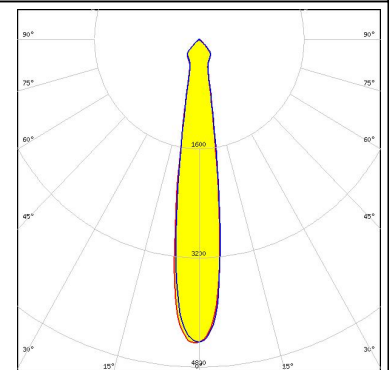

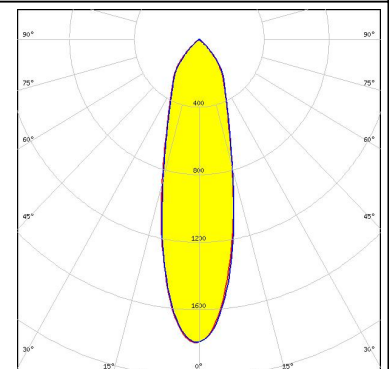
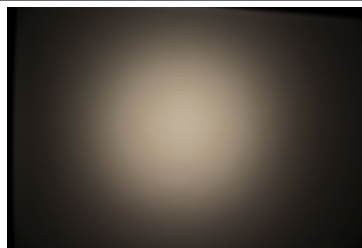

LED CDM-14 (Dim-To-Warm)
 FWHM 28.0°
 Efficiency 83 %
 Peak intensity 1.800 cd/lm
 Required components:
 C16142_HEKLA-SOCKET-K
 C14658_BARBARA-RZ-LENS
 Bender Wirth: 491 Typ L8

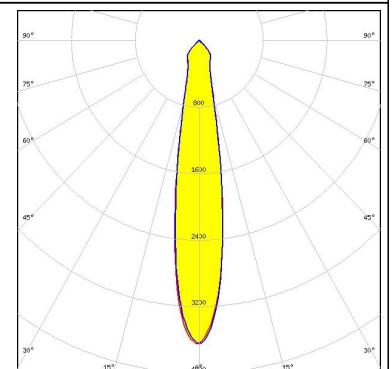
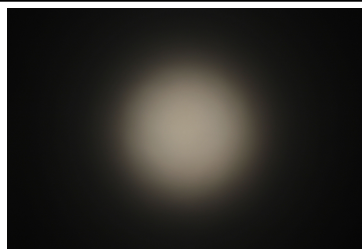

LED CDM-6 (Dim-To-Warm)
 FWHM 18.0°
 Efficiency 86 %
 Peak intensity 3.600 cd/lm
 Required components:
 C16142_HEKLA-SOCKET-K
 C14658_BARBARA-RZ-LENS
 Bender Wirth: 490 Typ L8

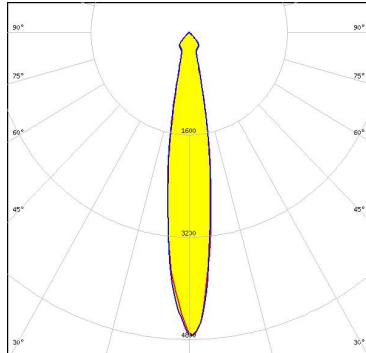
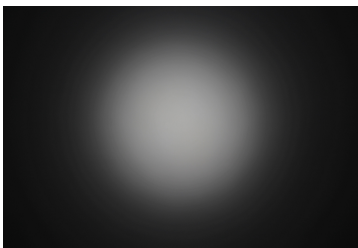
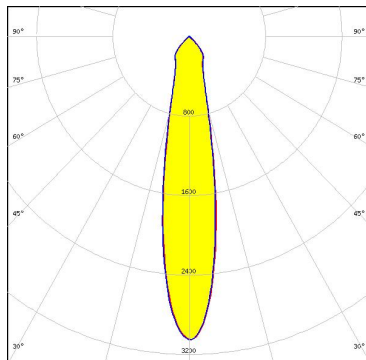

PHOTOMETRIC DATA (MEASURED):

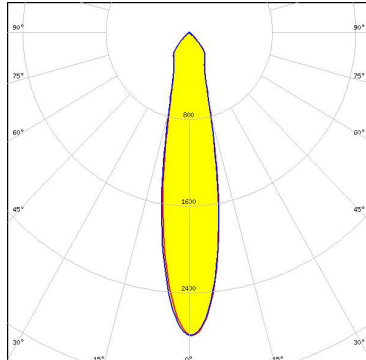
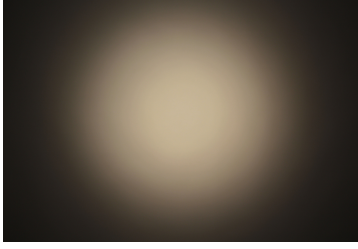
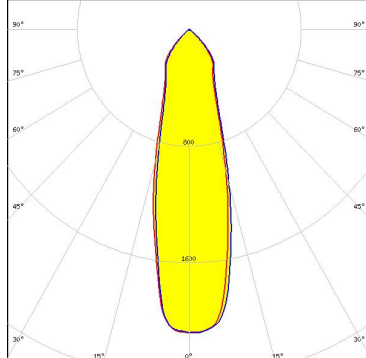
<p>LUMINUS</p> <p>LED CDM-9 (Dim-To-Warm)</p> <p>FWHM 17.0°</p> <p>Efficiency 90 %</p> <p>Peak intensity 4.800 cd/lm</p> <p>Required components: C16142_HEKLA-SOCKET-K Bender Wirth: 490 Typ L8</p>		
<p>LUMINUS</p> <p>LED CDM-9 (Dim-To-Warm)</p> <p>FWHM 21.0°</p> <p>Efficiency 85 %</p> <p>Peak intensity 3.100 cd/lm</p> <p>Required components: C16142_HEKLA-SOCKET-K C14658_BARBARA-RZ-LENS Bender Wirth: 490 Typ L8</p>		
<p>LUMINUS</p> <p>LED CTM-9 (Tunable White)</p> <p>FWHM 22.0°</p> <p>Efficiency 85 %</p> <p>Peak intensity 2.800 cd/lm</p> <p>Required components: C16142_HEKLA-SOCKET-K C14658_BARBARA-RZ-LENS Bender Wirth: 495 Typ L8</p>		
<p>LUMINUS</p> <p>LED CXM-14</p> <p>FWHM 29.0°</p> <p>Efficiency 94 %</p> <p>Peak intensity 2.100 cd/lm</p> <p>Required components: F15859_HEKLA-SOCKET-I</p>		

PHOTOMETRIC DATA (MEASURED):



LED CXM-9
FWHM 18.0°
Efficiency 94 %
Peak intensity 3.900 cd/lm
Required components:
F15255_HEKLA-SOCKET-C

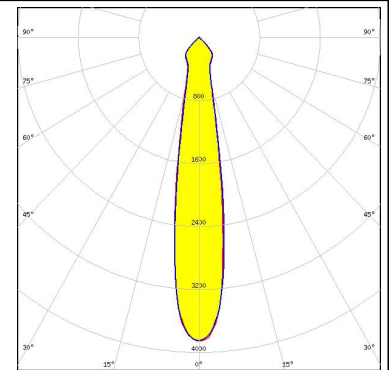

SAMSUNG

LED COB D Series LES 9.8 mm
FWHM 18.0°
Efficiency 94 %
Peak intensity 4.300 cd/lm
Required components:
F15255_HEKLA-SOCKET-C

SAMSUNG

LED COB D Series LES 9.8 mm
FWHM 22.0°
Efficiency 90 %
Peak intensity 2.800 cd/lm
Required components:
F15255_HEKLA-SOCKET-C
C14658_BARBARA-RZ-LENS

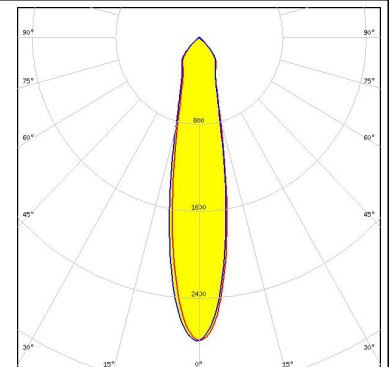

SAMSUNG

LED COB D Series LES 9.8 mm
FWHM 18.0°
Efficiency 94 %
Peak intensity 4.300 cd/lm
Required components:
F15255_HEKLA-SOCKET-C

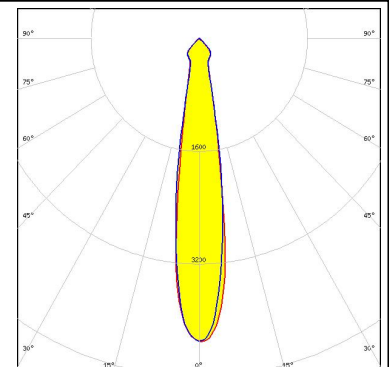

PHOTOMETRIC DATA (MEASURED):

SAMSUNG

LED LC010C G2
 FWHM 11.0°
 Efficiency 93 %
 Peak intensity 9.000 cd/lm
 Required components:
 F15255_HEKLA-SOCKET-C

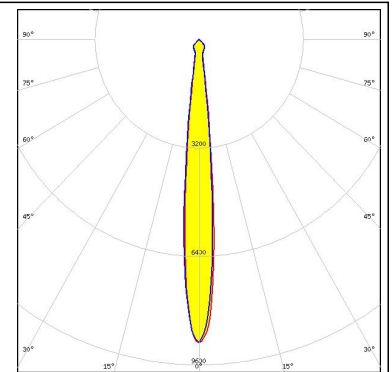

LED MJT COB LES 6
 FWHM 11.0°
 Efficiency 93 %
 Peak intensity 8.300 cd/lm
 Required components:
 F15255_HEKLA-SOCKET-C

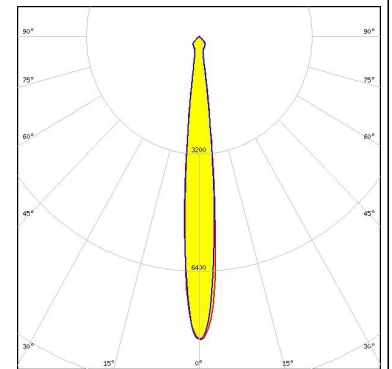

LED MJT COB LES 9.8
 FWHM 20.0°
 Efficiency 92 %
 Peak intensity 3.300 cd/lm
 Required components:
 F15255_HEKLA-SOCKET-C

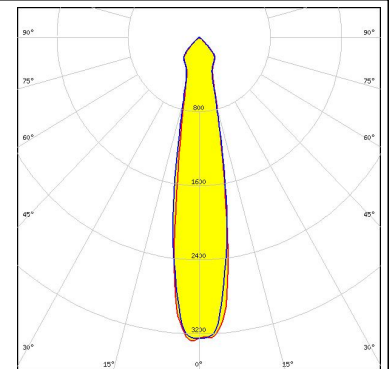
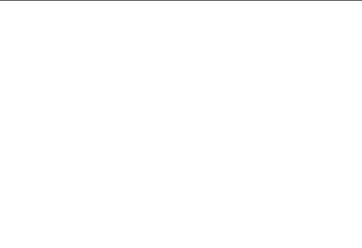

TRIDONIC

LED SLE G1 11mm 1000lm 927 Sunset R EXC
 FWHM 27.0°
 Efficiency 87 %
 Peak intensity 1.900 cd/lm
 Required components:
 F15859_HEKLA-SOCKET-I
 C14658_BARBARA-RZ-LENS

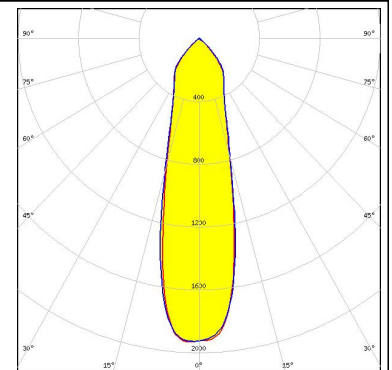
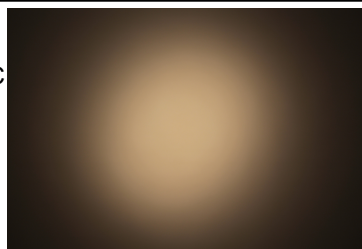

PHOTOMETRIC DATA (MEASURED):

TRIDONIC

LED SLE G1 15mm 2000lm 927 Sunset R EXC

FWHM 36.0°

Efficiency 86 %

Peak intensity 1.400 cd/lm

Required components:

F15859_HEKLA-SOCKET-I

C14658_BARBARA-RZ-LENS

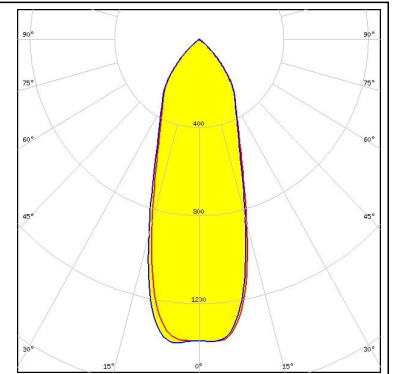
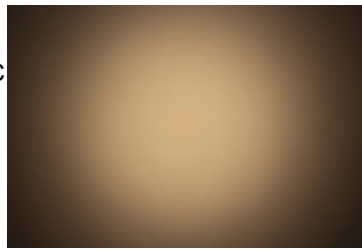

PHOTOMETRIC DATA (SIMULATED):

bridgelux.

LED V10 Gen6
FWHM 15.0°
Efficiency %
Peak intensity cd/lm

Required components:

F14988_HEKLA-SOCKET-E

bridgelux.

LED V10 Gen6
FWHM 15.0°
Efficiency 0 %
Peak intensity 0.000 cd/lm

Required components:

F14988_HEKLA-SOCKET-E

bridgelux.

LED V8 Gen6
FWHM 15.0°
Efficiency 0 %
Peak intensity 0.000 cd/lm

Required components:

F15253_HEKLA-SOCKET-A

bridgelux.

LED V8 Gen6
FWHM 15.0°
Efficiency 0 %
Peak intensity 0.000 cd/lm

Required components:

F15253_HEKLA-SOCKET-A

PHOTOMETRIC DATA (SIMULATED):

CITIZEN

LED CLL02x/CLU02x (LES10)
FWHM 18.0°
Efficiency 92 %
Peak intensity 4.300 cd/lm
Required components:
F15255_HEKLA-SOCKET-C

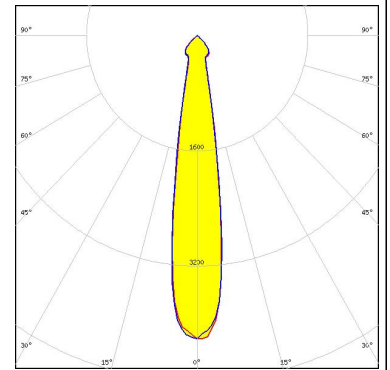

CREE

LED CXA/B 15xx
FWHM 15.0°
Efficiency 0 %
Peak intensity 0.000 cd/lm
Required components:
F15256_HEKLA-SOCKET-D

CREE

LED CXA/B 1816 & CXA/B 1820 & CXA 1850
FWHM 22.0°
Efficiency %
Peak intensity cd/lm
Required components:
F15254_HEKLA-SOCKET-B

CREE

LED CXA/B 1816 & CXA/B 1820 & CXA 1850
FWHM 22.0°
Efficiency 0 %
Peak intensity 0.000 cd/lm
Required components:
F15254_HEKLA-SOCKET-B

PHOTOMETRIC DATA (SIMULATED):



LED COB T-Type
FWHM 12.0°
Efficiency 91 %
Peak intensity 9.020 cd/lm
Required components:
F15848_HEKLA-SOCKET-G

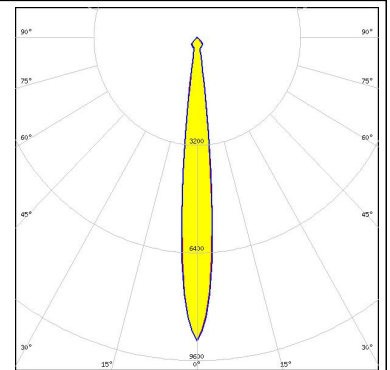

LED COB D Series LES 14.5 mm
FWHM 29.0°
Efficiency 88 %
Peak intensity 1.940 cd/lm
Required components:
F15859_HEKLA-SOCKET-I

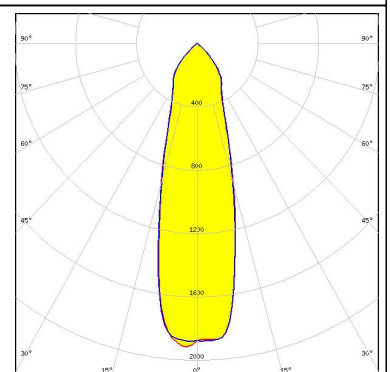

LED SLE G6 LES10
FWHM 15.0°
Efficiency 94 %
Peak intensity 5.800 cd/lm
Required components:
F15255_HEKLA-SOCKET-C

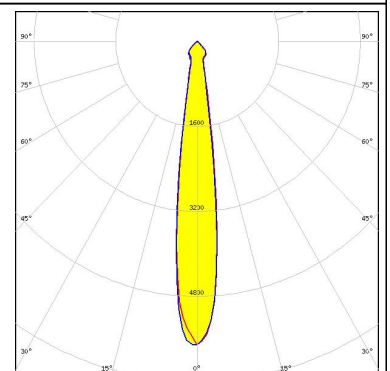

LED SLE G6 LES15
FWHM 25.0°
Efficiency 92 %
Peak intensity 2.400 cd/lm
Required components:
F15859_HEKLA-SOCKET-I

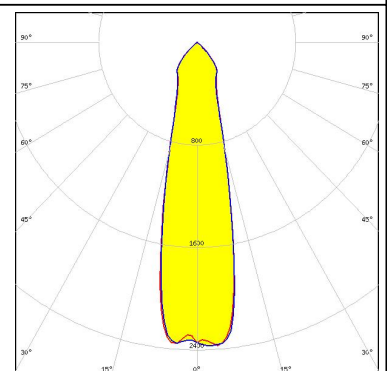

PHOTOMETRIC DATA (SIMULATED):

TRIDONIC

LED SLE G6 LES17
FWHM 29.0°
Efficiency 92 %
Peak intensity 2.010 cd/lm
Required components:
F15859_HEKLA-SOCKET-I

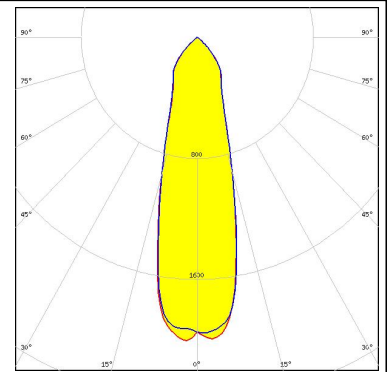

XICATO

LED XTM - 9mm LES
FWHM 17.0°
Efficiency 93 %
Peak intensity 4.810 cd/lm
Required components:
C15743_XTM-ADAPTER-50-B

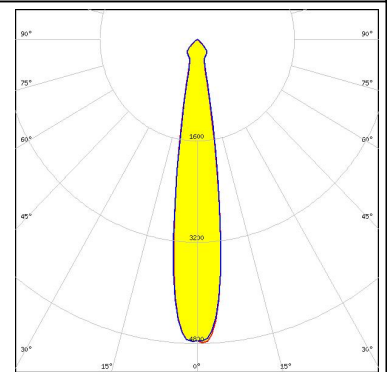

GENERAL INFORMATION:

NOTE: The typical beam angle will be changed by different color, chip size and chip position tolerance. The typical total beam angle is the full angle measured where the luminous intensity is half of the peak value.

Due to use of high power COB's with this product, special attention to proper thermal design is highly recommended. LEDiL has no liability for direct, indirect or consecutive damages arising from the LEDiL products being used outside of the recommended temperature range.

MATERIALS:

As part of our continuous research and improvement processes, and to ensure the best possible quality and availability of our products, LEDiL reserves the right to change material grades without notice.

PRODUCT DATA USER AGREEMENT AND DISCLAIMER:

The measured data in the provided downloadable LEDiL Product Datasheets and Mechanical 2D-Drawings is rounded and provided as reference for planning. LEDiL Oy's optical specifications have been verified by conducting performance testing of the products in accordance with the company's quality system. The reported data are averaged results of multiple measurements with typical variation. LEDiL Oy reserves the right to without prior notification make changes and improvements to its products.

LEDiL Oy assumes neither warranty, nor guarantee nor any other liability of any kind for the contents and correctness of the provided data. The provided data has been generated with highest diligence but the provided data may in reality not represent the complete possible variation range of all intrinsic parameters. Therefore, in certain cases a deviation from the provided data could occur.

LEDiL Oy reserves the right to undertake technical changes of its products without further notification which could lead to changes in the provided data. LEDiL Oy assumes no liability of any kind for the possible deviation from any provided data or any other damage resulting from the usage of the provided data.

The user agrees to this disclaimer and user agreement with the download or usage of the provided files.

LEDiL Oy

Joensuunkatu 13
FI-24240 SALO
Finland

LEDiL Inc.

228 West Page Street
Suite D
Sycamore IL 60178
USA

Local sales and technical support

www.ledil.com/where_to_buy

Shipping locations

Salo, Finland
Hong Kong, China

Distribution Partners

www.ledil.com/where_to_buy