

DESCRIPTION: INTERNAL DIMENSIONS - PLASTIC & METALIZED PLASTIC

DIMENSIONS (IN.)

	9	15	25	37
A	0.747	1.074	1.610	2.255
B*	0.126	0.126	0.126	0.126
C	0.707	1.034	1.575	2.214
D	0.259	0.271	0.271	0.271
E	0.621	0.948	1.487	2.11
F	0.152	0.147	0.147	0.162
G				0.842
H				0.222
J			0.454	1.069
K			0.562	0.558
PCB	0.323	0.323	0.323	0.323

SEE NOTE 1. →

SEE NOTE 2. →

NOTE:

- "B" DIMENSION MEASURED FROM BACK SIDE OF CONNECTOR FLANGE
- MIN. SAFE SPACING BETWEEN BACK SHELLS FOR PCB AND MOUNTED COMPONENTS
- THESE DIMENSIONS ARE GOOD FOR THE PLASTIC AND METALIZED PLASTIC BACK SHELLS

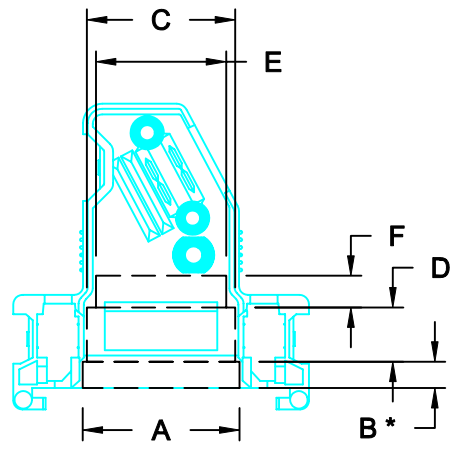

9-PIN

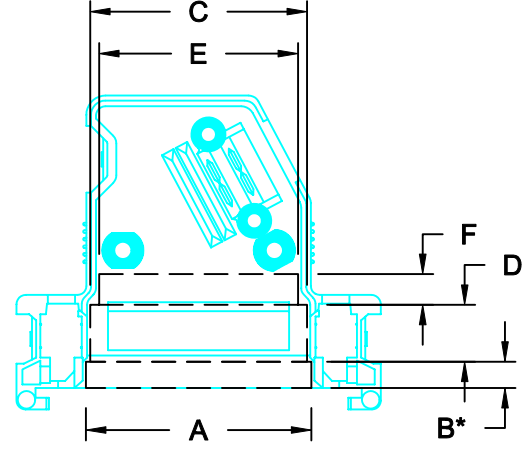

15-PIN

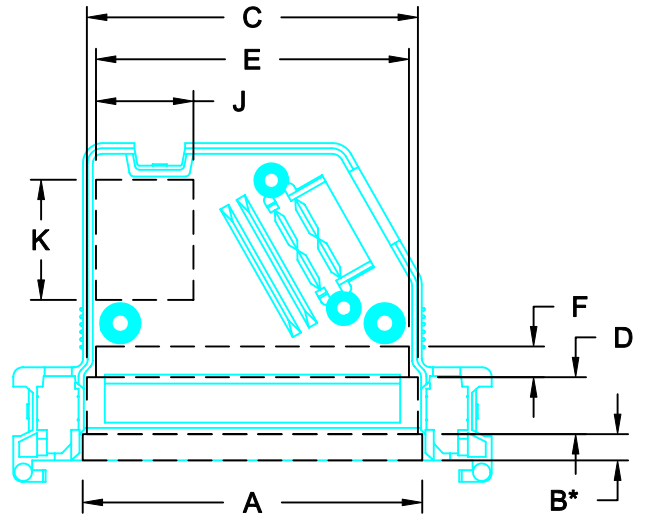

25-PIN

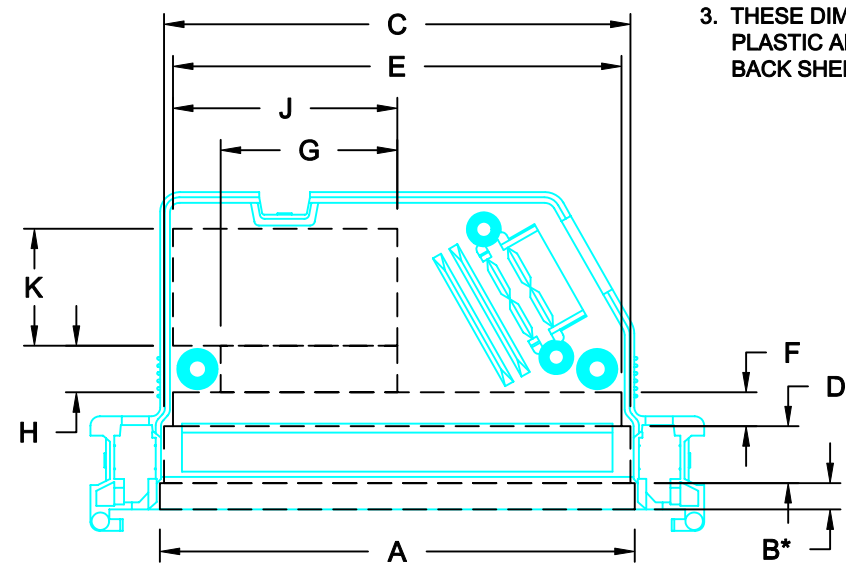

37-PIN

PLASTIC & METALIZED PLASTIC

DO NOT SCALE FROM DRAWING

RoHS COMPLIANT

	THESE DRAWINGS AND SPECIFICATIONS ARE THE PROPERTY OF NorComp AND SHALL NOT BE REPRODUCED, COPIED OR USED AS THE BASIS FOR THE MANUFACTURE OF SALE OF APPARATUS WITHOUT WRITTEN PERMISSION.		DRAWN: C. SMITH	DATE: 03-23-07
			CHECKED:	DATE:
<h1>NorComp</h1>		SCALE: N.T.S.	SHEET 1 OF 1	REV 0
		DWG NO. ID - 950 SERIES		