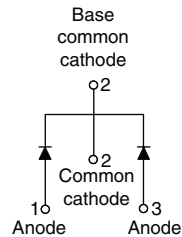


Hyperfast Rectifier, 2 x 15 A FRED Pt™


TO-220AB


FEATURES

- Hyperfast recovery time
- Low forward voltage drop
- Low leakage current
- 175 °C operating junction temperature
- Designed and qualified for AEC Q101 level

DESCRIPTION/APPLICATIONS

300 V series are the state of the art hyperfast recovery rectifiers designed with optimized performance of forward voltage drop and hyperfast recovery time.

The planar structure and the platinum doped life time control, guarantee the best overall performance, ruggedness and reliability characteristics.

These devices are intended for use in the output rectification stage of SMPS, UPS, dc-to-dc converters as well as freewheeling diodes in low voltage inverters and chopper motor drives.

Their extremely optimized stored charge and low recovery current minimize the switching losses and reduce over dissipation in the switching element and snubbers.

PRODUCT SUMMARY

| | |
|--------------------|----------|
| t_{rr} (maximum) | 36 ns |
| $I_{F(AV)}$ | 2 x 15 A |
| V_R | 300 V |

ABSOLUTE MAXIMUM RATINGS

| PARAMETER | SYMBOL | TEST CONDITIONS | VALUES | UNITS |
|---|----------------|-----------------------|-------------|-------|
| Peak repetitive reverse voltage | V_{RRM} | | 300 | V |
| Average rectified forward current | $I_{F(AV)}$ | $T_C = 153\text{ °C}$ | 15 | A |
| | | | 30 | |
| Non-repetitive peak surge current | I_{FSM} | $T_C = 25\text{ °C}$ | 150 | |
| Operating junction and storage temperatures | T_J, T_{Stg} | | - 65 to 175 | °C |

ELECTRICAL SPECIFICATIONS ($T_J = 25\text{ °C}$ unless otherwise specified)

| PARAMETER | SYMBOL | TEST CONDITIONS | MIN. | TYP. | MAX. | UNITS |
|-------------------------------------|---------------|--|------|------|------|---------------|
| Breakdown voltage, blocking voltage | V_{BR}, V_R | $I_R = 100\ \mu\text{A}$ | 300 | - | - | V |
| | | | | | | |
| Forward voltage | V_F | $I_F = 15\text{ A}$ | - | 1.0 | 1.25 | V |
| | | $I_F = 15\text{ A}, T_J = 125\text{ °C}$ | - | 0.85 | 0.95 | |
| Reverse leakage current | I_R | $V_R = V_R$ rated | - | - | 40 | μA |
| | | $T_J = 125\text{ °C}, V_R = V_R$ rated | - | 8 | 200 | |
| Junction capacitance | C_T | $V_R = 300\text{ V}$ | - | 38 | - | pF |
| Series inductance | L_S | Measured lead to lead 5 mm from package body | - | 8 | - | nH |



| DYNAMIC RECOVERY CHARACTERISTICS ($T_C = 25\text{ }^\circ\text{C}$ unless otherwise specified) | | | | | | |
|--|-----------|---|------|------|------|-------|
| PARAMETER | SYMBOL | TEST CONDITIONS | MIN. | TYP. | MAX. | UNITS |
| Reverse recovery time | t_{rr} | $I_F = 1\text{ A}$, $di_F/dt = 50\text{ A}/\mu\text{s}$, $V_R = 30\text{ V}$ | - | - | 36 | ns |
| | | $I_F = 1\text{ A}$, $di_F/dt = 100\text{ A}/\mu\text{s}$, $V_R = 30\text{ V}$ | - | - | 30 | |
| | | $T_J = 25\text{ }^\circ\text{C}$ | - | 33 | - | |
| | | $T_J = 125\text{ }^\circ\text{C}$ | - | 48 | - | |
| Peak recovery current | I_{RRM} | $T_J = 25\text{ }^\circ\text{C}$ | - | 2.8 | - | A |
| | | $T_J = 125\text{ }^\circ\text{C}$ | - | 6.5 | - | |
| Reverse recovery charge | Q_{rr} | $T_J = 25\text{ }^\circ\text{C}$ | - | 46 | - | nC |
| | | $T_J = 125\text{ }^\circ\text{C}$ | - | 160 | - | |

| THERMAL - MECHANICAL SPECIFICATIONS | | | | | | |
|--|-------------------|---------------------|------|---------|---------------------------|--|
| PARAMETER | SYMBOL | MIN. | TYP. | MAX. | UNITS | |
| Maximum junction and storage temperature range | T_J , T_{Stg} | - 65 | - | 175 | $^\circ\text{C}$ | |
| Thermal resistance, junction to case per diode | R_{thJC} | - | - | 1.4 | $^\circ\text{C}/\text{W}$ | |
| Marking device | | Case style TO-220AB | | 30CTH03 | | |

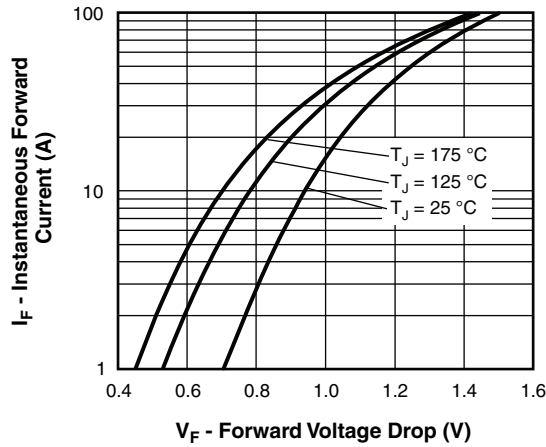
**Hyperfast Rectifier,
2 x 15 A FRED Pt™**
Vishay High Power Products


Fig. 1 - Typical Forward Voltage Drop Characteristics

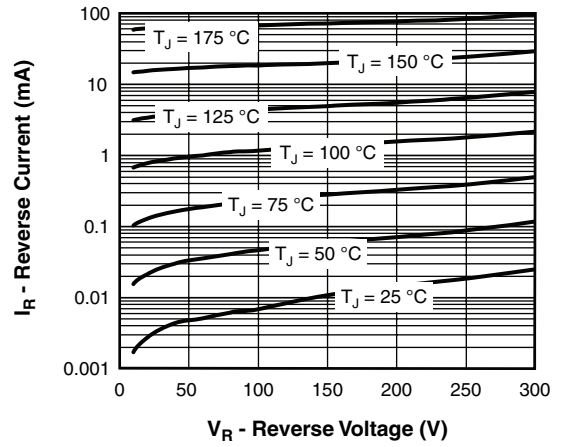


Fig. 2 - Typical Values of Reverse Current vs. Reverse Voltage

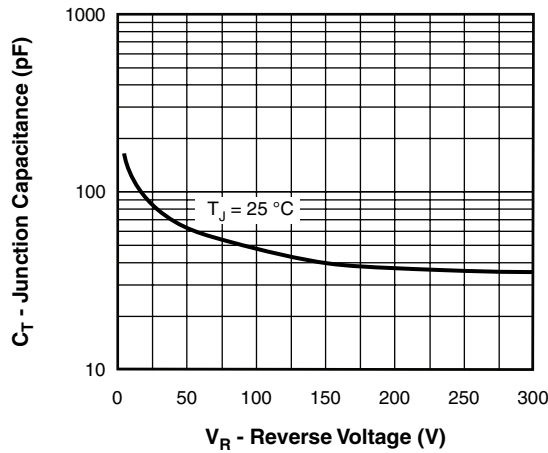
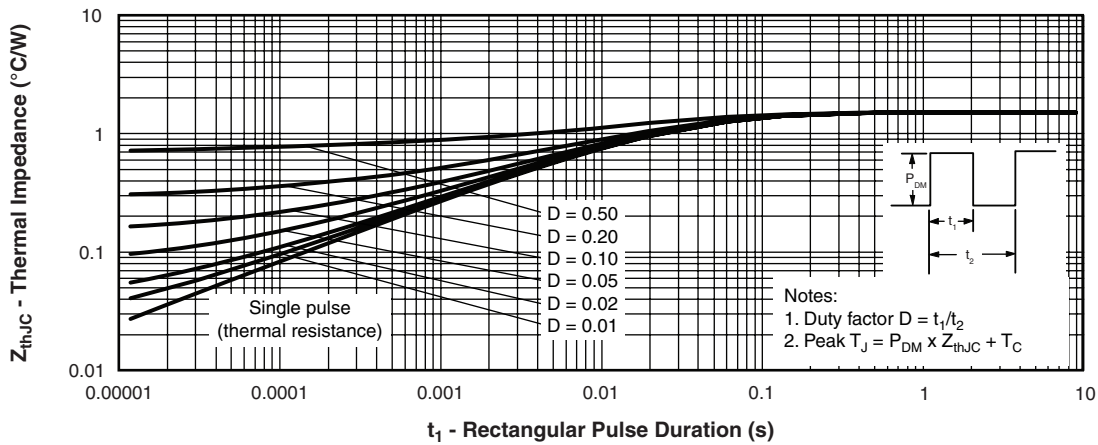


Fig. 3 - Typical Junction Capacitance vs. Reverse Voltage


 Fig. 4 - Maximum Thermal Impedance Z_{thJC} Characteristics

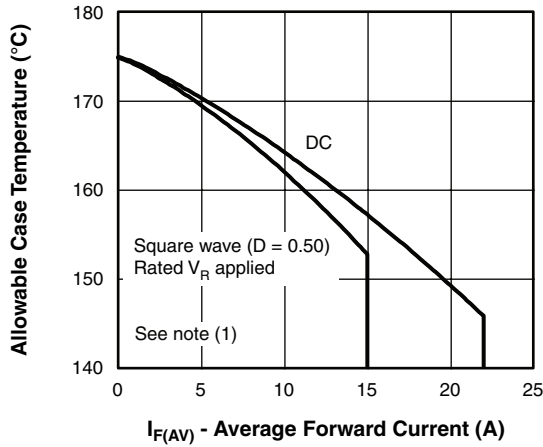


Fig. 5 - Maximum Allowable Case Temperature vs. Average Forward Current

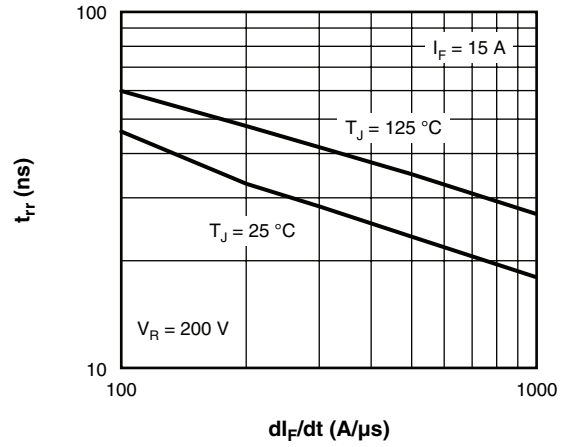


Fig. 7 - Typical Reverse Recovery Time vs. di_F/dt

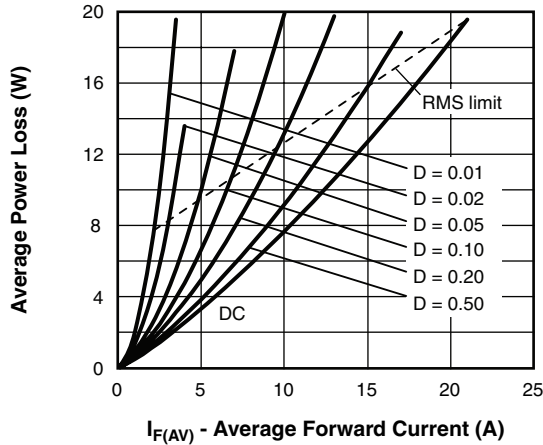


Fig. 6 - Forward Power Loss Characteristics

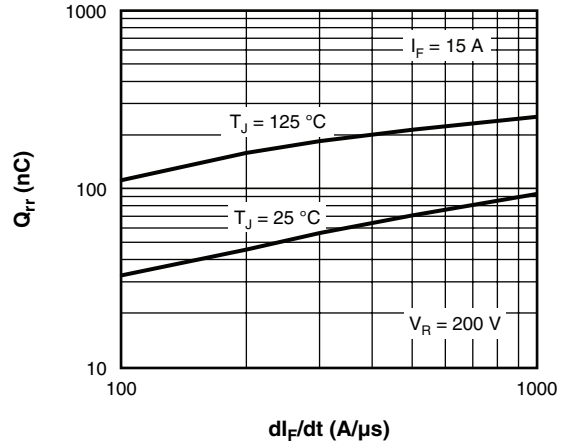


Fig. 8 - Typical Stored Charge vs. di_F/dt

Note

- (1) Formula used: $T_C = T_J - (P_d + P_{d_{REV}}) \times R_{thJC}$;
- P_d = Forward power loss = $I_{F(AV)} \times V_{FM}$ at $(I_{F(AV)}/D)$ (see fig. 6);
- $P_{d_{REV}}$ = Inverse power loss = $V_{R1} \times I_R (1 - D)$; I_R at V_{R1} = Rated V_R

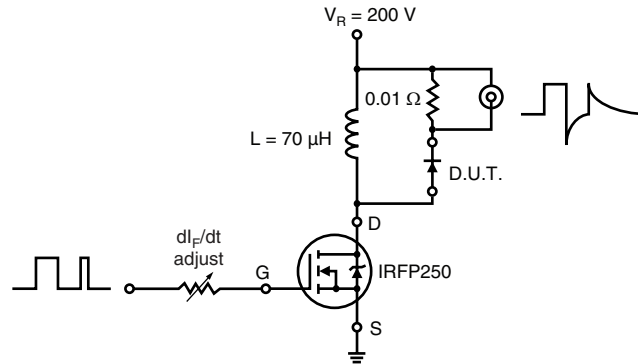
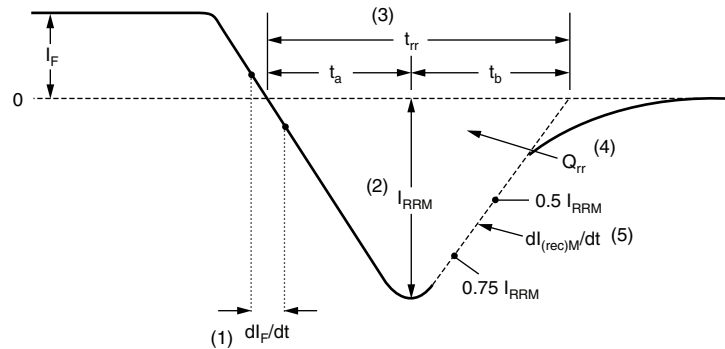


Fig. 9 - Reverse Recovery Parameter Test Circuit



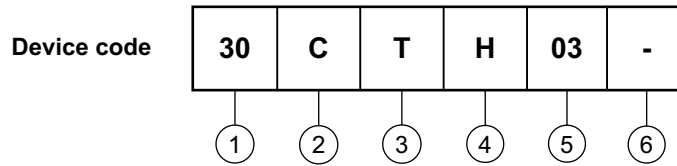
- (1) di_F/dt - rate of change of current through zero crossing
- (2) I_{RRM} - peak reverse recovery current
- (3) t_{rr} - reverse recovery time measured from zero crossing point of negative going I_F to point where a line passing through $0.75 I_{RRM}$ and $0.50 I_{RRM}$ extrapolated to zero current.
- (4) Q_{rr} - area under curve defined by t_{rr} and I_{RRM}
- (5) $dl_{(rec)M}/dt$ - peak rate of change of current during t_b portion of t_{rr}

$$Q_{rr} = \frac{t_{rr} \times I_{RRM}}{2}$$

Fig. 10 - Reverse Recovery Waveform and Definitions



ORDERING INFORMATION TABLE



- 1** - Current rating (30 = 30 A)
- 2** - C = Common cathode
- 3** - Package:
 - T = TO-220
- 4** - H = Hyperfast recovery
- 5** - Voltage rating (03 = 300 V)
- 6** -
 - None = Standard production
 - PbF = Lead (Pb)-free

Tube standard pack quantity: 50 pieces

| LINKS TO RELATED DOCUMENTS | |
|----------------------------|---|
| Dimensions | http://www.vishay.com/doc?95222 |
| Part marking information | http://www.vishay.com/doc?95267 |



Disclaimer

All product specifications and data are subject to change without notice.

Vishay Intertechnology, Inc., its affiliates, agents, and employees, and all persons acting on its or their behalf (collectively, "Vishay"), disclaim any and all liability for any errors, inaccuracies or incompleteness contained herein or in any other disclosure relating to any product.

Vishay disclaims any and all liability arising out of the use or application of any product described herein or of any information provided herein to the maximum extent permitted by law. The product specifications do not expand or otherwise modify Vishay's terms and conditions of purchase, including but not limited to the warranty expressed therein, which apply to these products.

No license, express or implied, by estoppel or otherwise, to any intellectual property rights is granted by this document or by any conduct of Vishay.

The products shown herein are not designed for use in medical, life-saving, or life-sustaining applications unless otherwise expressly indicated. Customers using or selling Vishay products not expressly indicated for use in such applications do so entirely at their own risk and agree to fully indemnify Vishay for any damages arising or resulting from such use or sale. Please contact authorized Vishay personnel to obtain written terms and conditions regarding products designed for such applications.

Product names and markings noted herein may be trademarks of their respective owners.