

D-SUB gender changer - VS-15-GC-ST/ST - 1652677

Please be informed that the data shown in this PDF Document is generated from our Online Catalog. Please find the complete data in the user's documentation. Our General Terms of Use for Downloads are valid (<http://phoenixcontact.com/download>)



D-SUB contact insert, shell size 2, with 15 signal contacts, contact type pin, gender changer, fixing with 4-40 UNC thread



Key commercial data

Packing unit	1 pc
Weight per Piece (excluding packing)	11.08 GRM
Custom tariff number	85366990
Country of origin	Germany

Technical data

Mechanical characteristics

Number of positions	15
Insertion/withdrawal cycles	≥ 200
Connection method	Gender changer
Cable exit	Straight

Ambient conditions

Ambient temperature (operation)	-55 °C ... 125 °C
---------------------------------	-------------------

Material data

Inflammability class according to UL 94	V0
Housing material	Steel, yellow chromated
Contact carrier material	Polyester GF
Contact material	Copper alloy
Contact surface material	Hard gold-plated over nickel

Electrical characteristics

Rated voltage (III/3)	125 V
-----------------------	-------

D-SUB gender changer - VS-15-GC-ST/ST - 1652677

Technical data

Electrical characteristics

Rated surge voltage	1 kV
Rated current	5 A

Classifications

eCl@ss

eCl@ss 4.0	27140816
eCl@ss 4.1	27260701
eCl@ss 5.0	27260701
eCl@ss 5.1	27260701
eCl@ss 6.0	27260705
eCl@ss 7.0	27440309
eCl@ss 8.0	27440309

ETIM

ETIM 2.0	EC000438
ETIM 3.0	EC000438
ETIM 4.0	EC000438
ETIM 5.0	EC000438

UNSPSC

UNSPSC 6.01	30211923
UNSPSC 7.0901	39121522
UNSPSC 11	39121522
UNSPSC 12.01	39121522
UNSPSC 13.2	39121522

Approvals

Approvals

Approvals

GOST

Ex Approvals

D-SUB gender changer - VS-15-GC-ST/ST - 1652677

Approvals

Approvals submitted

Approval details



Drawings

Dimensioned drawing

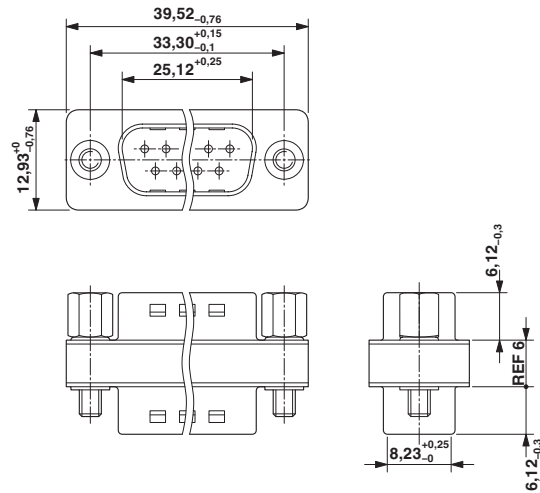

Gender changer