

Standard Rectifier

3~ Rectifier	
V_{RRM}	= 1800 V
I_{DAV}	= 90 A
I_{FSM}	= 350 A

ISOPLUS™
Surface Mount Power Device
3~ Rectifier Bridge

Part number

DMA90U1800LB

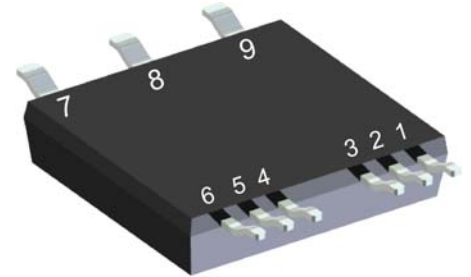

Backside: isolated

 E72873

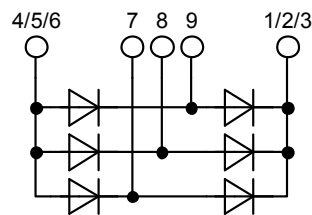

Features / Advantages:

- Rectifier diode
- Isolated back surface
- Low coupling capacity between pins and heatsink
- Enlarged creepage towards heatsink
- Application friendly pinout
- Low inductive current path
- High reliability

Applications:

- Line rectifying 50/60 Hz
- Drives
- SMPS
- UPS

Package: SMPD

- Isolation Voltage: 3000 V~
- Industry convenient outline
- RoHS compliant
- Epoxy meets UL 94V-0
- Soldering pins for PCB mounting
- Backside: DCB ceramic
- Reduced weight
- Advanced power cycling

Rectifier				Ratings			
Symbol	Definition	Conditions		min.	typ.	max.	Unit
V_{RSM}	max. non-repetitive reverse blocking voltage					1900	V
V_{RRM}	max. repetitive reverse blocking voltage					1800	V
I_R	reverse current	$V_R = 1800$ V	$T_{VJ} = 25^\circ\text{C}$			40	μA
		$V_R = 1800$ V	$T_{VJ} = 150^\circ\text{C}$			1.5	mA
V_F	forward voltage drop	$I_F = 30$ A	$T_{VJ} = 25^\circ\text{C}$			1.26	V
						1.79	V
		$I_F = 90$ A	$T_{VJ} = 150^\circ\text{C}$			1.20	V
						1.93	V
I_{DAV}	bridge output current	$T_C = 110^\circ\text{C}$ rectangular	$d = \frac{1}{3}$	$T_{VJ} = 175^\circ\text{C}$		90	A
V_{FO}	threshold voltage			$T_{VJ} = 175^\circ\text{C}$		0.81	V
r_F	slope resistance					12.7	m Ω
R_{thJC}	thermal resistance junction to case					1.1	K/W
R_{thCH}	thermal resistance case to heatsink				0.4		K/W
P_{tot}	total power dissipation			$T_C = 25^\circ\text{C}$		135	W
I_{FSM}	max. forward surge current	t = 10 ms; (50 Hz), sine	$T_{VJ} = 45^\circ\text{C}$	$V_R = 0$ V		350	A
						380	A
		t = 8,3 ms; (60 Hz), sine	$T_{VJ} = 150^\circ\text{C}$	$V_R = 0$ V		300	A
						320	A
I^2t	value for fusing	t = 10 ms; (50 Hz), sine	$T_{VJ} = 45^\circ\text{C}$	$V_R = 0$ V		615	A ² s
						600	A ² s
		t = 8,3 ms; (60 Hz), sine	$T_{VJ} = 150^\circ\text{C}$	$V_R = 0$ V		450	A ² s
						425	A ² s
C_J	junction capacitance	$V_R = 400$ V; f = 1 MHz		$T_{VJ} = 25^\circ\text{C}$		11	pF

Package SMPD		Ratings				
Symbol	Definition	Conditions	min.	typ.	max.	Unit
I_{RMS}	RMS current	per terminal			100	A
T_{VJ}	virtual junction temperature		-55		175	°C
T_{op}	operation temperature		-55		150	°C
T_{stg}	storage temperature		-55		150	°C
Weight				8.5		g
F_C	mounting force with clip		40		130	N
$d_{Spp/App}$	creepage distance on surface striking distance through air	terminal to terminal	1.6			mm
$d_{Spb/Apb}$		terminal to backside	4.0			mm
V_{ISOL}	isolation voltage	t = 1 second	3000			V
		t = 1 minute	2500			V

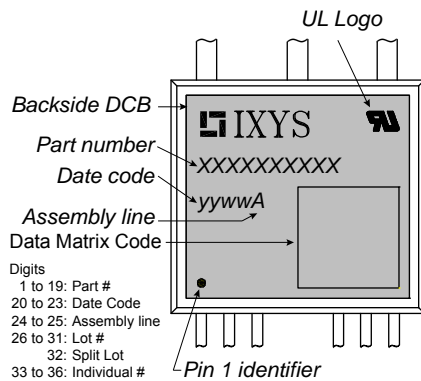

Part number

- D = Diode
- M = Standard Rectifier
- A = (up to 1800V)
- 90 = Current Rating [A]
- U = 3- Rectifier Bridge
- 1800 = Reverse Voltage [V]
- LB = SMPD-B

Ordering	Part Number	Marking on Product	Delivery Mode	Quantity	Code No.
Standard	DMA90U1800LB	DMA90U1800LB	Blister	45	511747
Alternative	DMA90U1800LB-TRR	DMA90U1800LB	Tape & Reel	200	511740

Equivalent Circuits for Simulation

* on die level

$T_{VJ} = 175^\circ\text{C}$

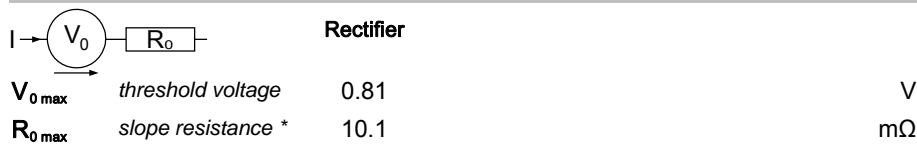

Outlines SMPD

A (8 : 1)

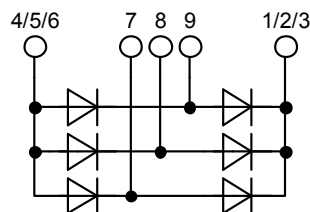
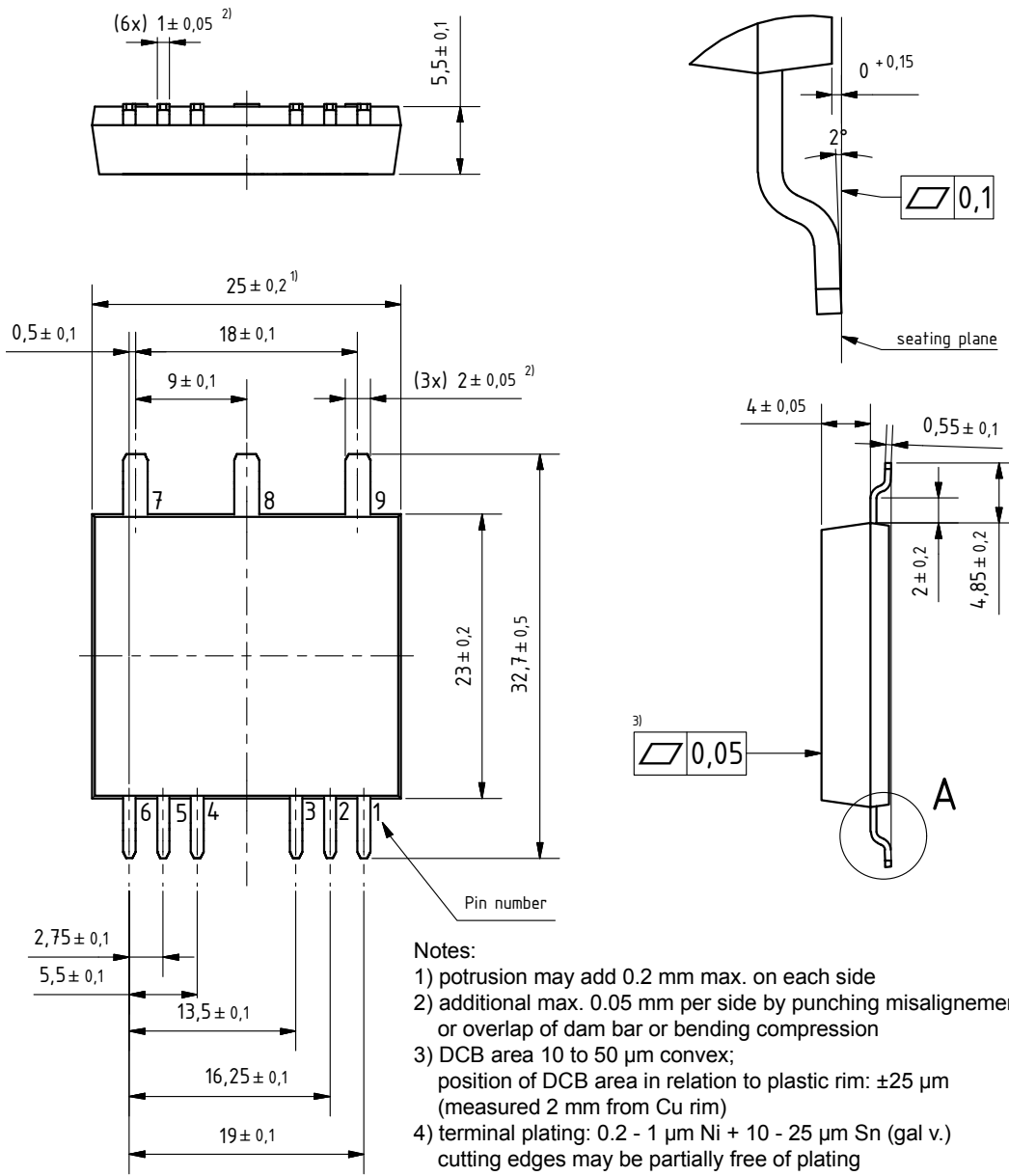

Rectifier

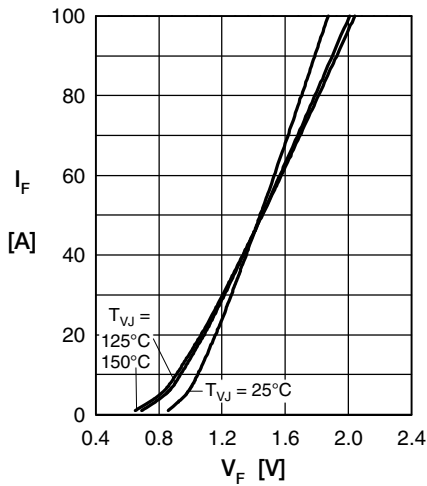

Fig. 1 Forward current vs. voltage drop per diode

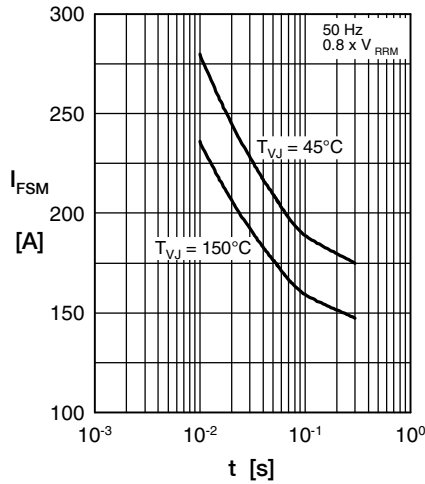

Fig. 2 Surge overload current vs. time per diode

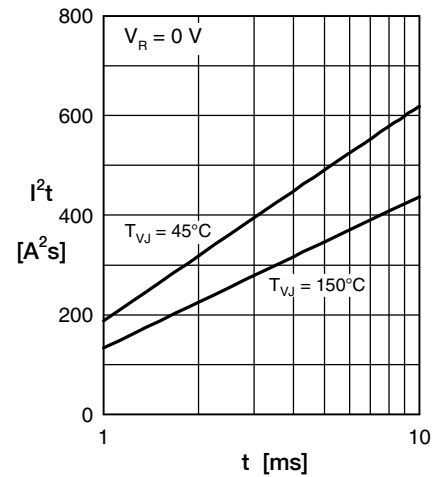

Fig. 3 I^2t vs. time per diode

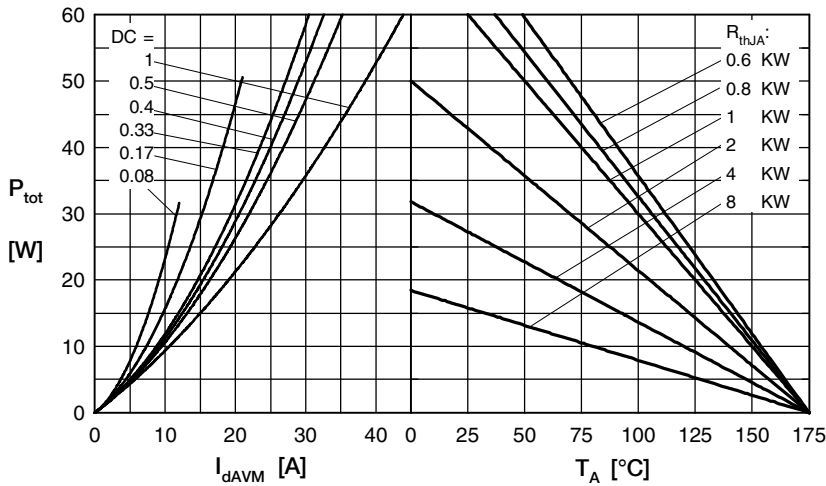

Fig. 4 Power dissipation vs. forward current and ambient temperature per diode

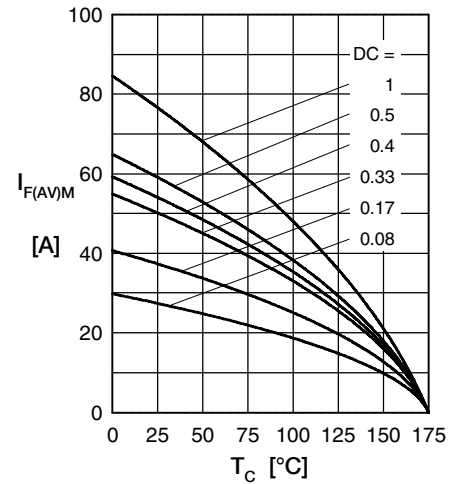

Fig. 5 Max. forward current vs. case temperature per diode

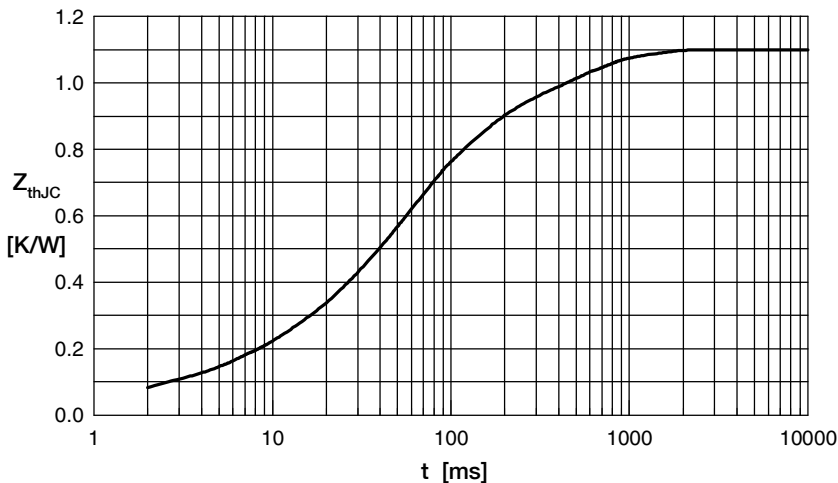

Fig. 6 Transient thermal impedance junction to case vs. time per diode

Constants for Z_{thJC} calculation:

i	R_{th} (K/W)	t_i (s)
1	0.030	0.0003
2	0.072	0.0045
3	0.092	0.0530
4	0.606	0.0520
5	0.300	0.4000